

# Technical data CLASSIC standard – Type 90

Technical details		Model size					
		XS	S	M	L	XL with centre partition wall	XL without centre partition wall
Load bearing capacity with uniformly distributed load (max. load/shelf)	in kg	75	75	75	75	75	75
Maximum volume of the largest single container which may be stored on any shelf in the cabinet	in l	44	20	20	31	20	44
Collection volume bottom tray	in l	49	22	22	35	2 x 23	49
Volumetric flow rate for 10-fold air exchange	in approx. m <sup>3</sup> /h	6	3	4	7	10	10
Pressure drop in the cabinet	in Pa	<1	<1	<1	<1	<1	<1

	Dimensions – interior fittings [in mm]																				
	XS						S			M			L			XL with centre partition wall			XL without centre partition wall		
	Width	Depth	Height	Width	Depth	Height	Width	Depth	Height	Width	Depth	Height	Width	Depth	Height	Width	Depth	Height			
Shelf	1090	430	35	490	430	35	490	430	35	790	430	35	536	430	35	1090	430	35			
Bottom tray	1085	440	105	485	440	105	485	440	105	785	440	105	523	440	105	1085	440	105			
Perforated sheet insert	1067	422	105	432	422	105	432	422	105	767	422	105	515	422	105	1067	422	105			

Front view	Side view	Top view
------------	-----------	----------

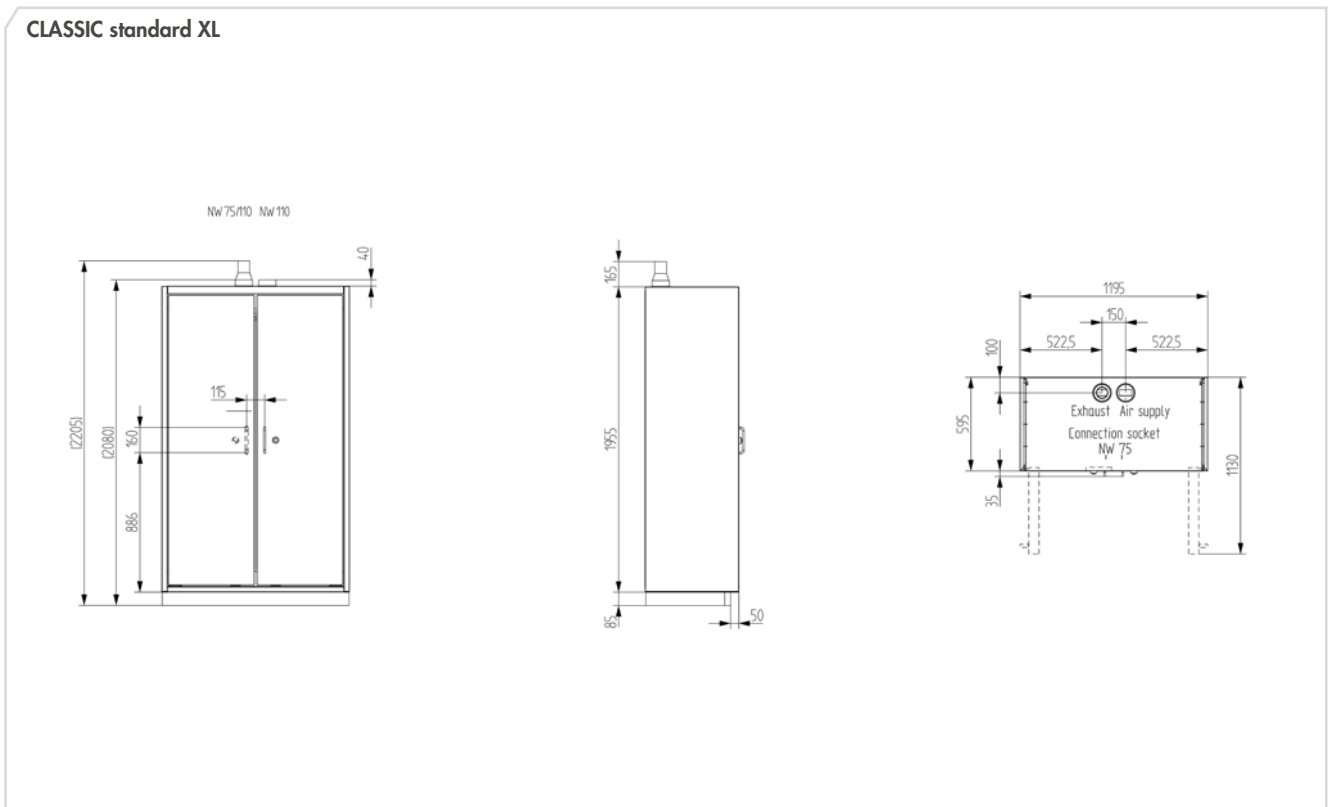

Front view	Side view	Top view
------------	-----------	----------

**CLASSIC standard L**

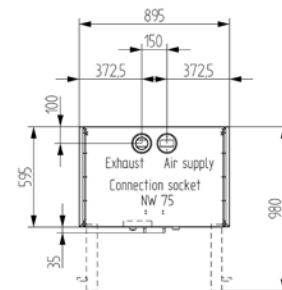
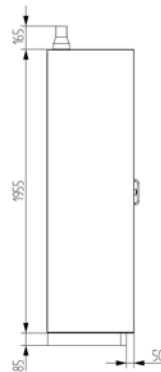

**CLASSIC standard M**

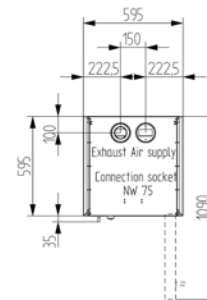
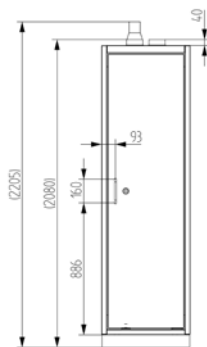

**CLASSIC standard XS**

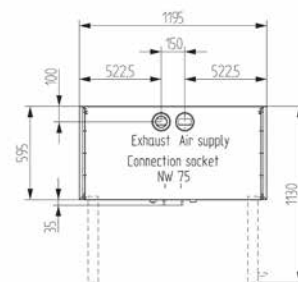
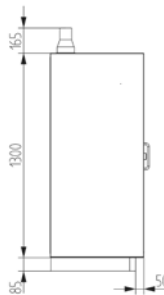
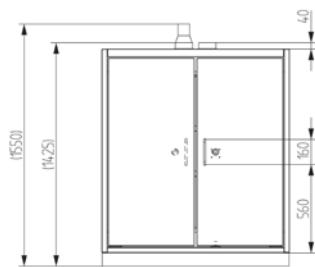

**CLASSIC standard S**

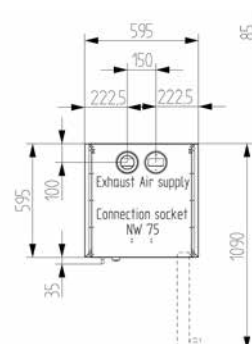
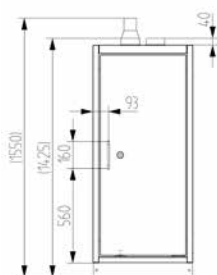

# Technical data CLASSIC SL – Type 90

Technical details			Model size			
			M	ML	XL with centre partition wall	XL without centre partition wall
Load bearing capacity with uniformly distributed load (max. load/shelf)	in kg	Pull-out tray V*	30	30	30	60
		Pull-out tray E**	50	50	50	60
		Shelf	–	–	75	75
Maximum volume of the largest single container which may be stored on any shelf in the cabinet	in l	Pull-out tray V*	7	10	9	19
		Pull-out tray E**	15	21	19	39
		Shelf with bottom tray	–	–	20	43
Collection volume	in l	Pull-out tray V*	8	11	10	21
		Pull-out tray E**	17	23	21	43
		Bottom tray	–	–	23	48
Volumetric flow rate with 10-fold air exchange rate	in approx. m <sup>3</sup> /h	–	4.5	6	10	10
Pressure drop in the cabinet	in Pa	–	<1	<1	<1	<1

Dimensions – interior fittings [in mm]				Model size								
				M			ML			XL with centre partition wall		
	Width	Depth	Height	Width	Depth	Height	Width	Depth	Height	Width	Depth	Height
Pull-out tray V*	389	410	60	389	560	60	465	410	60	862	410	60
Pull-out tray E**	389	410	120	389	560	120	465	410	120	862	410	124
Shelf	–	–	–	–	–	–	536	430	35	860	430	35
Bottom tray	–	–	–	–	–	–	523	440	105	855	440	65
Perforated sheet insert	–	–	–	–	–	–	515	422	105	–	–	–

### Adjustable heights CLASSIC SL XL V1 – V4 [in mm]

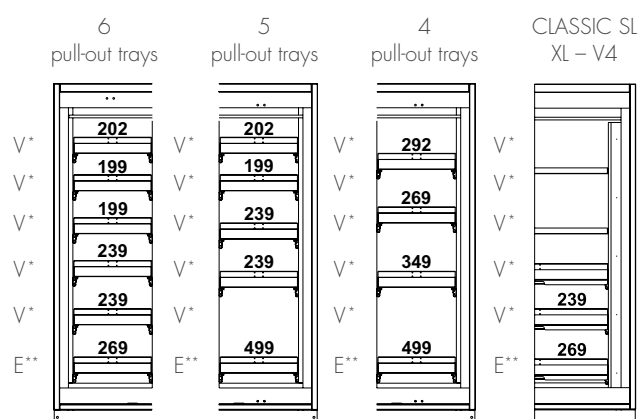

#### Container types

Type of container	Height
Glass laboratory bottle 0.5 litre	195 mm
Glass laboratory bottle 1.0 litre	235 mm
Glass laboratory bottle 2.5 litre	265 mm
Combination container 12.0 litre	345 mm
Combination container (with high funnel) 12.0 litre	490 mm

Other height possible on request.

\*V = for small containers 0.5 – 2.5 litre

\*\*E = for larger containers, e.g. container 12 litre

### Adjustable heights CLASSIC SL M, ML, and XL V5 – V10 with centre partition wall [in mm]

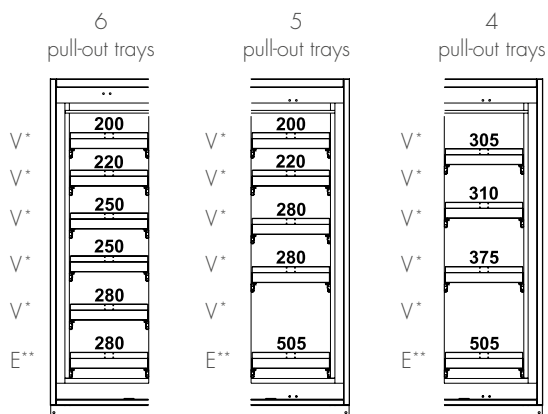

#### Container types

Type of container	Height
Glass laboratory bottle 0.5 litre	195 mm
Glass laboratory bottle 1.0 litre	235 mm
Glass laboratory bottle 2.5 litre	265 mm
Combination container 12.0 litre	345 mm
Combination container (with high funnel) 12.0 litre	490 mm

Other height possible on request.

\*V = for small containers 0.5 – 2.5 litre

\*\*E = for larger containers, e.g. container 12 litre

# Technical data CLASSIC SL – Type 90

Front view	Side view	Top view
------------	-----------	----------

## CLASSIC SL – XL

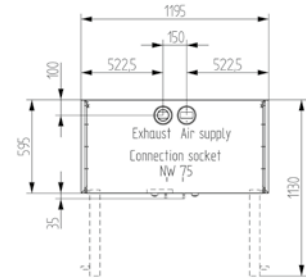
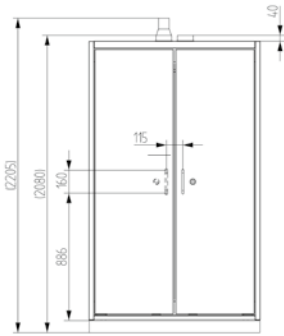

## CLASSIC SL – M

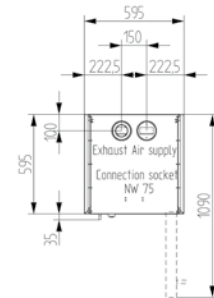
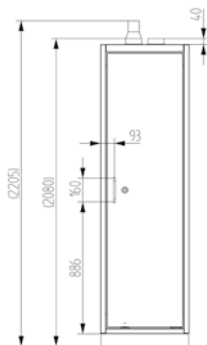

## CLASSIC SL – ML

